

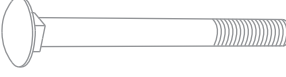



H3H CUBE GUIDE

- 1** M10 x100 
- 2** M10 x110 
- 3** M10 x100 
- 4** M10 
- 5** M10 

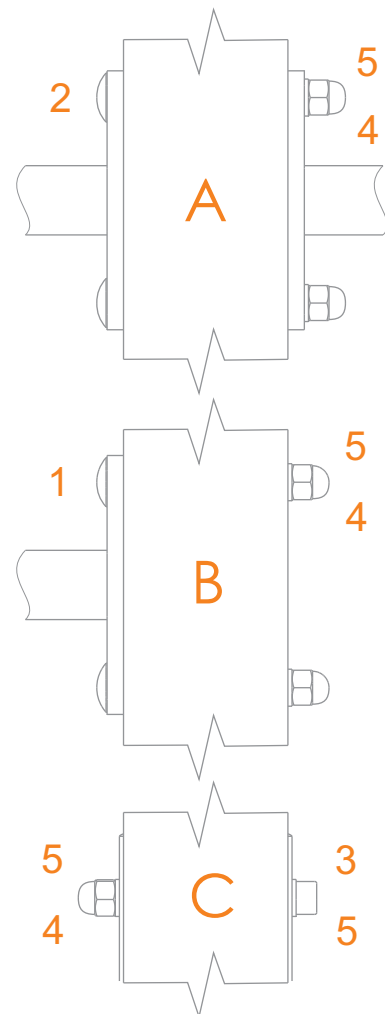
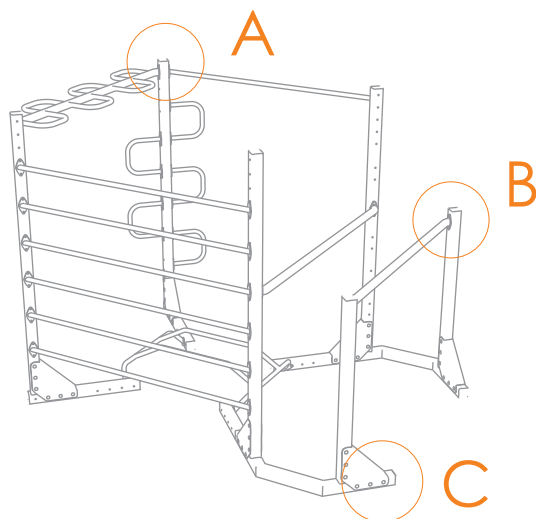

Please read the guide thoroughly and provide the area.

First we put everything together and if we are ready with the construction, we screw all the bolts (from up to down). Watch out always for the screws way, to make it similar way (looks nice).

Put down in the middle the push up bar (central part). Connect all the four short black part to the push up bar with the 100mm band hinge screws. Use always washer!

After we can stabilize the corner parts with the allen screw. Use always on both side washer by this kind of screw. Just put the nut on the screw, after we finished the construction you have to screw all the bolts.

After we can connect the four pillar to the corner parts. We use the allen screws also here on both side nut.

We put the 1 and 2 coll bars on the pillars with the 100 mm band hinge screws. Watch out where is two bars on the pillar on the same level we use always the 110mm bolt with one nut.

After we put all the bars to the pillars, we can scerw all the bolts from up to down.

If you have any question, feel free to ask.